

TENDER NO: 06/ 2021 Dated 12th Aug 2021
INVITATION OF TENDERS for
CONSTRUCTION WORKS OF PARKING SHEDS FOR
NEW FACULTY RESIDENCES AT
INDRAPRASTHA INSTITUTE OF INFORMATION TECHNOLOGY DELHI
IIITD CAMPUS AT OKHLA-III, NEW DELHI 110020



INDRAPRASTHA INSTITUTE of
INFORMATION TECHNOLOGY DELHI



PROJECT AND OPERATIONS DEPT.
IIIT DELHI

INDEX

S. No.	SUB HEAD	PAGE NO.
1	TENDER DOCUMENT	2 - 32
2	SPECIFICATIONS/LIST OF MAKES /LAYOUT	Attached
3	AGREEMENT PERFORMA	Attached
4	SCHEDULE OF QUANTITIES	Attached
5	Drawings	Attached

Indraprastha Institute of Information Technology, New Delhi (IIIT-Delhi)

DATED- 12th Aug 2021

TENDER NOTICE

1. Last Date & Time of issue of tender documents from **12th Aug 2021**
2. Last Date & Time of receipt of tender **28th Aug 2021** upto 3.00 p.m.

CE, IIIT-Delhi, Okhla, New Delhi-110020 on behalf of Registrar, IIIT-Delhi invites sealed item rate tenders from eligible contractors for similar works.

Name of work: **Civil and Structural fabrication works for Four-wheeler Parking Shed for new Faculty residences at Indraprastha Institute of Information Technology (IIIT-Delhi) Campus, Okhla Phase-III, New Delhi-110020**

Location : **Rear side areas of New Faculty Residence**
Time of completion : **60 days**

Earnest Money Deposit: **Rs. 40,000/- (Rupees Forty Thousand only)** is to be submitted with tender document as earnest money. The above payment shall be made in the shape of deposit at pay order/demand draft of a scheduled bank issued in favour of **IIIT Delhi Collection** payable at New Delhi.

Tender documents can be downloaded from IIITD website (www.iiitd.ac.in) and submitted with non- refundable DD of **Rs. 1180/- including GST** in favour of **IIIT Delhi Collection** as cost of tender.

- 1) The tenders shall be placed in sealed envelopes with a name of work and due date written on the envelope and addressed to the CE, IIITD. The approved contractors in two envelopes shall submit complete tender documents. **1st envelope** shall contain eligibility criteria and cost of tender as stated above in case of the downloaded version.
- 2) The eligible contractors who have carried out similar works in IIIT-D/Govt Deptts/PSU/Reputed Pvt. sector /MNCs are to submit the experience certificates for the works and registration certificates with Govt. Depts. if any. Enclose the said certificates along with the EMD/ Bid Security Declaration & tender fee in **Envelope-1**.
- 3) Experience of having successfully completed similar works during last seven years ending on the last day of the month previous to the one in which the tenders are invited. The similar works are defined as works of civil works.

Three similar works not less than 40% of est cost	Rs 8 lacs each Or
Two similar works not less than 60% of est cost	Rs 12 lacs each Or
One similar work not less than 80% of est cost	Rs 16 lacs each

- 4) One completed works of similar nature either part of 3) or separate one costing not less than 40% of estimated cost ie Rs 8 lacs with some

Central/State/Autonomous/Central PSU/State PSU/local authority formed under any Act published in Central/State Gazette.

- 5) The applications not supported with requisite experience certificates, GST registration certificate, TIN no. and PAN No. in **Envelope-1** shall not be entertained
- 6) Average Annual Turnover Interior works should be at least Rs 25 lacs during immediate last three consecutive financial years ending 31st Mar 2021.
- 7) Should not have incurred any loss in the more than two years in the last five years ending 31st Mar 2021.
- 8) Should submit solvency certificate of 40% of estimate ie for 8 lacs from their bankers.
- 9) Performance certificates must be submitted by the vendors for the works.
- 10) The applications not supported with requisite experience certificates, GST certificate, TIN no. and ITCC in **Envelope-1** shall not be entertained.
- 11) The 2nd **envelope** shall contain the financial bids including Priced Schedule of Quantities, Form of Tender, Conditions of Tender, Articles of Agreement, Brief Specifications, Condition of contract, Drawings all duly signed by the authorized signatory of the firms.

All these envelopes are to be put in a single envelope duly super-scribed the name of work, and addressed to CE, (IIITD) and with their address. In case the tenderer does not fulfill the laid down eligibility criteria or fails to deposit the earnest money in prescribed form, financial bid shall not be opened.

Tenderers shall seal the tender affix their initials and put stamp on each and every page of tender document before submission. The tender of the contractor, who submits in-complete tender document or submits more than one tender for one work, shall not be considered at all.

Tenders will be received by the CE up to 3.00 P.M on **28th Aug 2021** and will be opened by him or his authorized representative in the office of Registrar, IIITD on the same day at 3.30 P.M.

First the Technical Bids will be opened and screened. The bids shall be examined whether the EMD is in order and the bidder meets the minimum eligibility criteria specified above. Those bidders whose EMD is in order, meets the minimum eligibility criteria, has submitted all the required documents and meet the technical requirements shall be considered for opening of financial bid. Conditional tenders would not be accepted. Financial bids in respect of contractors who do not fulfill above criterion shall not be opened.

- 12) No Xerox / certified copies of tenders shall be accepted, if submitted these tenders shall be rejected.

CE

CONDITIONS

1. The time allowed for carrying out the Interior work will be 60 days from the 3rd day after the date of written orders to commence the work.
2. The site for the work is available.
3. During execution of works, because of some unforeseen circumstances to enable him to complete the work as per terms of the contract, shall not relieve the contractor from any liability or obligations under the contract and he shall be responsible for the acts, defaults and neglects of any sub-contractor, his agents or workmen as fully as if they were the acts, defaults or neglects of the contractor, his agents or workmen.
4. The Contractor shall be required to deposit an amount equal to 3% of the tendered value of the work as performance guarantee in the form of an irrevocable bank guarantee bond of any scheduled bank or State Bank of India in accordance with the form prescribed or in the form of fixed deposit receipt etc. within 7 days of the issue of letter of acceptance. The performance guarantee shall have the validity up to **31st Dec 2021**.
5. Tenderers are advised to inspect and examine the site and its surrounding at their own cost and satisfy themselves before submitting their tenders as to the nature of the ground and sub-soil (so far as is practicable), the form and nature of the site, means of access to the site, the accommodation they may require and in general shall themselves obtain all necessary information as to risk, contingencies and other circumstances which may influence or affect their tender. A tenderer shall be deemed to have full knowledge of the site whether he inspects it or not and no extra charges consequent on any misunderstanding or otherwise shall be allowed. The tenderer shall be responsible for arranging and maintaining at own cost all materials, tools and plants, water, electricity, access, facilities for workers and all other services required for executing the work unless otherwise specifically provided for in the contract documents. Submission of a tender by a tenderer implies that he has read this notice and all other contract documents and has made himself aware of the scope and specification of the work to be done, local condition and other factors having a bearing on the execution of the work.
6. The Accepting Authority (IIITD) does not bind himself to accept the lowest or any other tender and reserves to him/herself the authority to reject in whole or part, any or all of the tenders received without the assignment of any reason. All tenders in which any of the prescribed conditions are not fulfilled or for any condition, including that of conditional rebate is put forth by the tenderer shall be summarily rejected.
7. Canvassing, whether directly or indirectly, in connection with tenders is strictly prohibited and the tenders submitted by the contractor who resort to canvassing will be liable to rejection.

8. The Accepting Authority reserves to himself the right of accepting the whole or any part of the tender and the tender shall be bound to perform the same at the rates quoted.
9. Tenders shall remain open for acceptance for a period of 60 days from the date of opening of the tenders. If any tenderer withdraws his tender before the said period for issue of letter of acceptance, whichever is earlier or makes any modification in the terms and condition of the tender which are not acceptable to the IIITD, then IIITD shall, without prejudice to any other right or remedy, be at liberty to forfeit 50% of the said earnest money absolutely besides black listing of the tenderer.
10. The notice-inviting tender shall form a part of the contract document. The successful tenderer/contractor shall, sign the necessary contract documents consisting of the notice inviting tender, all the documents including additional conditions, specification and drawings, if any forming the tender as issued at the time of invitation of tender and acceptance thereof with any correspondence leading thereto within the time specified in the letter communicating the acceptance of the tender. In case of delay, the earnest money may be forfeited and the tender cancelled or the contract enforced as per the terms of the tender and the invitation to tender and the tenderer shall thus be bound by the condition of contract even though the formal agreement has not been executed and signed within the specified time by the tenderer.
11. The work shall be carried out as per general of conditions of contract for central PWD works 7/8 (Tender Contract) and form part of the agreement/document.
12. Contract is liable to be terminated by the IIITD without payment of any compensation, if subsequent to the acceptance of tender the contractor is black-listed by, or enters into partnership or employs any black listed contractor of the IIITD or any other department, or Govt. or its, undertakings.
13. Cost of Bidding
 - 13.1 The bidder shall bear all costs associated with the preparation and submission of his Bid, and the Employer will in no case be responsible and liable for those costs.
14. Clarification of Bidding Documents
 - 14.1 A prospective bidder requiring any clarification of the bidding documents may notify the Employer in writing/mail at the Employer's address indicated in the invitation to bid not later than 3 days before the Date of Submission of Tenders.
Email- admin-project@iiitd.ac.in
15. Currencies of Bid and Payment
 - 15.1 The unit rates and the prices shall be quoted by the bidder entirely in Indian Rupees. All payments will be invariably made in Indian Currency (Indian Rupees.)

16. PROTECTION OF ENVIRONMENT AND OTHER LAWS:

The contractor shall take all reasonable steps to protect the environment on and off the Site and to avoid damage or nuisance to persons or to property of the public or others resulting from pollution, noise or other causes arising as a consequence of his methods of operation.

During continuance of the contract, the contractor and his sub-contractors shall abide at all times by all existing enactments on environmental protection and other local Acts/ Laws/ rules made there under, regulations, notifications and bye-laws of local authorities or any other law, bye-laws, regulations that may be passed or notification that may be issued in this respect in future by the State/ Local authority.

For and on behalf of the
REGISTRAR
Indraprastha Institute of Information Technology,
New Delhi

TENDER

I/We have read and examined and understood the notice inviting tender, schedule, A, B, C, D, E & F, Specifications applicable, drawings & Designs, General Rules and Directions, Conditions of Contract, clauses of contract, special conditions, Schedule of Rate & other documents and Rules referred to in the conditions of contract and all other contents in the tender document for the work.

I / We hereby tender for the execution of the work specified for the IIITD within the time specified in Schedule ' F ', viz., schedule of quantities and in accordance in all respects with the specifications, designs, drawings and instructions in writing referred to in Rule - 1 of General Rules and Directions and in Clause 11 of the Conditions of contract and with such materials as are provided for, by, and in respect in accordance with, such conditions so far as applicable.

We agree to keep the tender open for sixty (60) days from the due date of its opening and not to make any modifications in its terms and condition.

If I / we, fail to furnish the prescribed performance guarantee within prescribed period, I / we agree that the said Director, IIITD or his successors in office shall without prejudice to any other right or remedy, be at liberty to forfeit the said earnest money absolutely. Further, if I / we fail to commence work as specified, I / we agree that Director, IIITD or his successors in office shall without prejudice to any other right or remedy available in law, be at liberty to forfeit the said earnest money and the performance guarantee absolutely, otherwise the said earnest money shall be retained by him towards security deposit to execute all the works referred to in the tender documents upon the terms and conditions contained or referred to therein and to carry out such deviations as may be ordered, up to maximum of the percentage mentioned in Schedule ' F ' and those in excess of that limit at the rates to be determined in accordance with the provision contained in Clause 12.2 and 12.3 of the tender form. Further, I / We agree that in case of forfeiture of earnest money or both Earnest Money & Performance Guarantee as aforesaid, I / We shall be debarred for participation in the re-tendering process of the work.

I / We hereby declare that I / we shall treat the tender documents drawings and other records connected with the work as secret / confidential documents and shall no communicate information / derived there from to any person other than a person to whom I / we am / are authorized to communicate the same or use the information in any manner prejudicial to the safety of the State.

Dated.

Witness:

Signatures of Contractor

Address:

Postal Address

Occupation:

LETTER OF SUBMISSION

The CE
Indraprastha Institute of Information Technology, Delhi
Okhla Phase-III
(Behind Govind Puri Metro Station)
New Delhi-110020.

I/We, the undersigned, have read and examined in detail, the specifications and all bidding documents and hereby declare that:

Price and Validity

1. All the rates quoted in our proposal are in accordance with the terms and conditions as specified in the bid document. All the prices and other terms and conditions of this proposal are valid for a period of 60 calendar days from the date of opening of bid.
2. We do hereby confirm that our bid prices include all taxes/levies/GST.
3. We hereby declare that if any tax law is altered, we shall pay the same.

Earnest Money

We have enclosed EMD in the form of demand draft no....., dated.....favoring IIIT, Delhi payable at New Delhi issued / drawn onBank for Rs._____-/- (Rupees _____ Thousand only), as desired.

We declare that all the works shall be performed strictly in accordance with the technical specifications and other tender conditions with no deviations.

Qualifying Data

We confirm that all information/data have been submitted as required in tender document.

We hereby declare that our proposal is made in good faith, without collusion for fraud and the information contained in the proposal is true and correct to the best of our knowledge and belief. I/We agree that in case any information is found to be incorrect the tender is liable to be rejected at any point of tendering process.

Bid submitted by us is properly sealed and prepared so as to prevent any subsequent alteration and replacement.

We understand that you are not bound to accept the lowest or any bid you may receive.

Thanking you,
Yours faithfully,
(Signature and seal of Tenderer with name, designation and contact no.)

ACCEPTANCE

The above tender (as modified by you as provided in the letters mentioned hereunder) is accepted by me for and on behalf of Registrar, IIITD for a sum of

Rs. ----- (Rupees -----)

The documents referred to below shall form part of this Contract Agreement: -

- NIT
- EMD
- Performa for Agreement
- Additional conditions.
- Special conditions
- Schedule of Quantities &
- Drawings
- Latest General conditions of contract for CPWD Works with up to date correction slip

For & on behalf of
Registrar
IIIT-D

Signature.

Dated.....

Designation.....

SCHEDULES

SCHEDULE 'A' Schedule of quantities (Enclosed)	: Enclosed
SCHEDULE 'B' Schedule of materials to be issued to the contractor	NIL
SCHEDULE 'C' Tools and plants to be hired to the contractor	NIL
SCHEDULE 'D' Extra schedule for specific requirements/documents for the work, if any,	NIL
SCHEDULE 'E' Schedule of component of Cement, Steel, other materials, Labour etc. for price escalation.	NIL
CLAUSE 10 CC Component of Cement - expressed as percent of total value work,	N/A
Component of Steel-expressed as percent of total work.	N/A
Component of civil (except cement & steel) / Electrical construction Materials-expressed as percent of total value of work.	N/A
Component of labour-expressed as per cent of total value of work.	N/A
Component of P.O.L. - expressed as percent of total value work.	N/A
SCHEDULE 'F' Reference to General Conditions of contract.	

Name of Work: Civil and Structural fabrication works for Four-wheeler Parking Shed for new Faculty residences at Indraprastha Institute of Information Technology (IIIT-Delhi) Campus, Okhla Phase-III, New Delhi-110020

Earnest Money Deposit: **Rs. 40,000/- (Rupees Forty Thousand only)** is to be submitted with tender document as earnest money. The above payment shall be made in the shape of deposit at pay order/demand draft of a scheduled bank issued in favour of IIIT Delhi Collection payable at New Delhi.

- i. **Performance Guarantee-** The contractor, for due and faithful performance of the Contract, shall obtain and submit to the Owner such security of **3%** of the Contract Value within 7 days after the receipt of the Letter of Acceptance, in the form of BG Performa as appendix to tender from a scheduled Bank /FD providing such security shall be subject to the approval of the Owner. The cost of complying with the requirement of this Clause shall be borne by the Contractor.

Period of Validity of performance Bond

The performance bond shall be valid as at Conditions Cl 4 and till the Contractor has executed and completed the Works in accordance with the Contract. This security shall be returned to the contractor within 14 days of the issue of the said Completion Certificate.

Claim under Performance Security

Prior to making a claim under the performance security the Owner shall, in every case, notify the Contractor stating the nature of the default in respect of which the claim is to be made.

- ii. **Security Deposit / Retention money** shall be Two and half percent (2.5%) of the value of executed works and will be deducted from each and every payment made to the contractor against running account bill submitted for the work done at site.
- iii. Defect Liability period 12 months from date of completion.
- iv. Liquidated damages In case of delay on account of reasons attributable to the Contractor Liquidated Damages shall be levied. The amount of Liquidated Damages payable by the Contractor to the Employer would be 0.25% of the value of order for each calendar day of delay subject to a maximum of 5% of the value of order after which Employer reserves the right to terminate the contract without prejudice to the rights of the Employer.

General Rules & Direction:

Officer inviting tender:

Registrar (IIITD)

Definitions

2(v) Engineer-in-Charge	CE
2(viii) Accepting Authority	DIRECTOR, IIITD
2(x) Percentage on cost of materials and labour to cover all overheads and profits.	15%
2(xi) Standard Schedule of Rates	DSR (latest)
2(xii) Department	IIIT-D
9(ii) Standard CPWD contract Form	CPWD form 8 -2010 with up to date correction slips.

Clause 1

- | | |
|---|--------|
| (i) Time allowed for submission of Performance Guarantee From the date of issue of letter of acceptance | 4 days |
| (ii) Maximum allowable extension beyond the period (Provided in (I) above | 7days |

Clause 2

Authority for fixing compensation under clause 2.	Director, IIITD
---	-----------------

Clause 2A

Whether clause 2A shall applicable	No
------------------------------------	----

Clause 5

Number of days from the date of issue of letter Acceptance for reckoning date of start	3 days
--	--------

Time allowed for construction	60 days
-------------------------------	---------

Clause 6, 6A

Clause applicable - (6 or 6A)	Clause 6A
-------------------------------	-----------

Clause 7

Gross work to be done together with net payment /adjustment or advance for material collected, if any since the last such payment for being eligible to interim payment.	Rs 10 Lakhs.
--	--------------

Clause 10A

List of testing equipment to be provided by the contractor at site lab.

As required

Clause 10 B (ii)

Whether Clauses 10B (ii) (iv) shall be applicable
-----do-----10B(iii) -----

Yes
No

Clause 10CA Escalation

Not Applicable

Clause 10CC Escalation

Not Applicable

Clause 11

Specification to be followed for execution of work

CPWD Specifications Latest,
Part I & II with Up-to-date
correction slips

Clause 12

Deviation limit beyond which clauses 12.2 & 12.3 shall
Apply for building work

Any extent, No limits set

Clause 16

Competent Authority for deciding reduced rates.

Director, IIITD

Clause 17

Contractor liable for Damages defects during
maintenance period

Applicable

Clause 18

List of mandatory machinery, tools & plants to be
deployed by the contractor at site

As per the site requirement.

Clause 36(i)

Requirement of Technical Representative (s)

As per requirement.

Clause 25

Arbitration Clause

As per special conditions

SPECIAL CONDITIONS

1. In the event of the tender being submitted by a firm, it must be signed by a person duly authorized through a power of attorney issued by all the partners and a certified copy of the power of attorney should be enclosed with the forwarding letter or separately by each member thereof, or in the event of the absence of any partner, it must be signed on his behalf by a person holding a power of attorney authorizing him to do so and such power of attorney shall be produced with the tender and it must disclose that the firm is registered under the Indian partnership Act.

Each and every signature given shall be separately witnessed. A Contractor or a contractor who himself / themselves has/have tendered or who may tender for the work shall not witness the tender of another person for the same work. Failure to observe this condition would render tenders of the contractors tendering as well as witnessing the tenders liable for summary rejection.

2. The conditions for item rate tender only will be applicable as given in general conditions of contract for central PWD works latest. As mentioned there in also, in event no rate has been quoted for any items leaving space bolts in figure (s), word(s) and amount blank, it will be presumed that the contractor has included the cost of this/these item(s) in other item(s) and rate for such items will be considered as zero and work will be required to be executed accordingly.
3. Rates quoted as percentage below/above in the tender will be summarily rejected.
4. It must be understood that the work has to be completed as per the time provided in the contract and as such time is the essence of the contract.
5. The quantities furnished in the bills of quantities are only probable quantities liable to alternation by omission, deduction or addition, and it would be clearly understood that the contract is **not a lump sum contract** and the IIITD do not, in any way, assure the tenderer or guarantee that the said probable quantities are correct or that the work would correspond thereto. Payments will be regulated on the actual quantities of work authorized done and measured at the accepted rates. No claims due to change in quantities (+ or -) will be entertained. The drawings, forming parts of complementary installations work specifications and the bills of quantities, of the contract, are explanatory of and are to one another, representing together the works / to be carried out. If neither the drawings nor the specifications nor the accepted bills of quantities include any part/parts the intention to include which is nevertheless clearly inferred and which are obviously necessary for the proper completion of the works/ installations, all such parts shall be supplied and executed by the contractor at no extra charge. Anything contained in one or another of (a) the drawings, (b) the specifications and (c) the accepted bills of quantities and not found in the others will be equally binding as if it were contained in each of them.
6. No alterations, which are made by the tenderer in the drawings, specifications, conditions or probable quantities accompanying this notice will be recognized and if any such alterations are made the tender, will be invalid. Conditional tenders will however be liable for rejection.

7. The tenderer must obtain for himself on his own responsibility and at his own expense all the information necessary, including risks, contingencies and other circumstances to enable him to make a proper tender and to enter into a contract with the IIITD. He must examine the drawings, specifications, conditions and so on and must inspect the site of work, examine the nature of the ground and the subsoil (so far as is practicable) and acquaint himself with local conditions, means of access to the work, storage facilities or areas for staff colony, the nature of the work, in fact all matters pertaining thereto before he submits his tender.
8. The tenderer shall also bear all expenses in connection with the preparation and submission of his tender and attendance for subsequent negotiations/clarifications.
 - (I) Omission, neglect or failure on the part of the tenderer to obtain requisite and reliable information on any matter affecting his tender, the contract and the construction, completion, maintenance, (dismantling and disposal) of the work shall not relieve the tenderer whose tender is accepted from any liability in respect of the contract.
 - (II) The tenderer whose tender is accepted shall not be entitled to make any claim for increase in the rates quoted and accepted excepting in pursuance of any specific provision in the contract.
9. The Contractor, upon award of work, shall furnish the following details for the approval of the Engineer in charge:
 - 9.1. The names of manufacturers of specialized items such as patented water proofing systems / materials, doors, flooring tiles, false ceilings, insulating materials, wind mill, cement, steel, glazing, and any other materials etc. which he proposes to use in the work.
 - 9.2. The makes and types of fittings, materials, subject to the makes and type stipulated in the specifications, which he proposes to use in the work.
 - 9.3. The details of licenses granted to him and/or to professional qualified and/or licensed technical personnel on his staff who will be engaged on the work (and submit, if called for, the licenses for inspection by the Officer in charge in consultation with Engineer in charge).
 - 9.4. Only approved agencies/ skilled workers shall be deployed to carry out requisite specialized items of work. The Officer/ Engineer in charge's decision in consultation with Architect's/ in this regard shall be binding to all the parties concerned.
10. The rates quoted in the bills of quantities shall unless specified otherwise will be for all heights, depths deemed to be for finished work in-situ/ item by item as provided for, and shall include cost for all necessary material and labours, all necessary tools and plants and machinery, sheds, marking out, clearing site, etc. and for all taxes, octroi, excise, VAT works contract and any other tax or duty

levied by Government, Central or Local, or Local Authority,/as subsumed and GST, if any as applicable.

- 10.1 The rates shall be firm and not be subject to any variations in exchange rates, in taxes, duties etc. in railway freight and the like including labour conditions, etc. The rates are not subject to any escalation.
11. It will be the sole responsibility of the contractor to procure all the equipments/materials and other materials required for the work.
12. The IIITD further reserves the right to delete or reduce at any time, any section of the bills of quantities without assigning any reasons whatsoever there for and no claim will be entertained in this regard.
13. The tenderer whose tender is accepted is bound to execute formal agreement with the IIITD within one week of the date of intimation of award of work in accordance with the draft agreement which will include conditions of tender, form of tender (general conditions of contract for central PWD works 2010), Articles of Agreement, Bills of quantities, Conditions of contract, Special conditions if any, the drawings and specifications, but his liability under the contract shall commence from the date of written order to commence work whether the formal agreement is drawn or not.

The Contractor shall bear all expenses in connection with the execution of the said agreement including fees for stamping and registration of documents as required.

14. The Security Deposit will bear no interest what so ever until the date of release.
15. a) The contractor, upon award of work, shall submit a memorandum of procedure giving the outline of his general scheme, programme and time table, in the form of a chart that shall be scrutinized and approved (with modifications as necessary), which shall become the approved programme for execution. The approved programme shall be the basis for assessment of comparative progress under the relevant conditions of contract.
(b). Over and above, the contractor has to supply programme chalked out showing important milestones to be achieved and the progress actually achieved compared with, the target of the same in the programme and shortfall, if any planned for being made up in the programme for next month.
17. (a) The work in general shall conform to the CPWD Specifications latest with up to date correction slips & any other latest civil specification published by CPWD, New Delhi and the "Specifications for works".
(b) In case items not covered by the general specifications referred above, reference shall be made to the appropriate I.S. Code.
(c) Should there be any difference in the particular specifications of individual item of work and the description of item as given in the Schedule of quantity, the latter shall prevail, which will be as per the relevant drawing.
(d), In case of any work for which there is no specification in I.S. specifications or in the specifications forming part of tender documents or in case there is any variation, such work shall be carried out in all respects in accordance with the instructions to be issued by the Engineer in charge.

18. On acceptance of the tender the Contractor shall in writing and at once inform the IIITD and the Architects/Officer In charge the name of his accredited representative(s) who will be responsible to take instructions from the Architects / Officer in Charge.

The work of any part of it shall not be transferred, assigned or sublet without the written consent of the IIITD.

19. The Contractor shall be required to co-operate and work in co-ordination with and afford reasonable facilities for such other agencies / specialists / interior designers / consultants as may be employed by the Architects / Project Management Consultant/ Officer in Charge on other works / sub-works in connection with the project/scheme of which this work forms a part.

20. The Contractor shall get the necessary insurance done for their personal employed/ company insurance, third party insurance, marine insurance, all risk insurance or any other insurance as required.

21. ***The Contractor shall make arrangements of carrying water and electricity beyond one point where same shall be provided and recovery @1% of the cost of works shall be effected accordingly.***

22. The Contractor is required to comply with all Acts of Government relating to labour, safety, environment and other Rules and Regulations made there under from time to time and to submit at the proper times all particulars and statements required to be furnished to the appropriate Authorities.

23. Delay and extension of time

If in the opinion of the Architect/PMC/Owner the Work is delayed:

- a. By force majeure, or
- b. By reason of any exceptionally inclement weather, or
- c. By reason of proceedings taken or threatened by or dispute with adjoining or neighboring owners or public authorities arising otherwise than through the Contractor's own default, or
- d. By the works or delays of other Contractor or tradesmen engaged or nominated by the Owner or the Architect and not referred to in the Schedule of Quantities and/or Specification, or
- e. By reason of Architect's/ Owner Instructions to delay work, or
- f. By reason of civil commotion, local combination of workmen or strike or lock-out affecting any of the building traders, or
- g. In consequence of the Contractor not having received in due time necessary Instructions from the Architect/Owner for which he shall have specifically applied in writing,

Then the Owner shall make a fair and reasonable extension of time for completion of the Contract Work; in case of such strike or lock-out the Contractor shall, as soon as may be, give written notice thereof to the Architect/Owner, but the Contractor shall nevertheless constantly use his endeavors to prevent delay and shall do all that may reasonably be required to the satisfaction of the

Architect to proceed with the work.

24. Failure by Contractor to comply with Architect's Instructions
If the Contractor after receipt of written notice from the Architect requiring compliance fails within ten days to comply with such further drawings and/or Architect's Instructions the Owner with the consent of the Architect may employ and pay other persons to execute any such work whatsoever that may be necessary to give effect thereto, and all costs incurred in connection therewith shall be recoverable from the Contractor.
25. **Termination or Abridgment of Contract by the Owner**
- a) If the Contractor being an individual or a Firm commit any 'Act or Insolvency' or shall be adjudged an Insolvent or being an Incorporated Company or Society shall have an order for compulsory winding up made against it or pass an effective resolution for winding up voluntarily or subject to the supervision of the Court and of the Official Assignee of the Liquidator in such acts of insolvency or winding up shall be unable within seven days after notice to him requiring him to do so, to show to the reasonable satisfaction of the Architect that he is able to carry out and fulfill the Contract, and to give security therefore, if so required by the Architect, or
 - b) If the Contractor (whether an individual, Firm, Incorporated Company or Society) shall suffer execution to be issued, or
 - c) Shall suffer any payment under this Contract to be attached by or on behalf of any or the creditors of the Contractor, or
 - d) Shall assign or sublet this Contract without the consent in writing of the Architect/PMC first obtained, or
 - e) Shall charge or encumber this Contract or any payments due or which may become due to the Contractor there under, or
 - f) If the Architect/PMC shall certify in writing to the Owner that the Contractor:
 - i. Has abandoned the Contract, or
 - ii. Has failed to commence the works, or has without any lawful excuse under these Conditions suspended the progress of the works for 14 days after receiving from the Architect/PMC/Owner written notice to proceed, or
 - iii. Has failed to proceed with the works with such due diligence and failed to make such due progress as would enable the works to be completed within the time agreed upon, or
 - iv. Has failed to remove materials from the site or to pull down and replace work for seven days after receiving from the Architect written notice the said materials or work were condemned and rejected by the Architect under these conditions, or
 - v. Has neglected or failed persistently to observe and perform all or any of the acts, matters or things by this Contract to be observed and performed by the Contractor for seven days after written notice shall have been given to the Contractor requiring the Contractor to observe or perform the same, or
 - vi. Has to the detriment of good workmanship or in defiance of the Architect's Instructions to the contrary sub-let any part of the Contract,
26. Then and in any of the said cases the Owner with the written consent of the Architect/PMC may, notwithstanding any previous waiver, after giving seven days' notice in writing to the Contractor, determine the Contract, but without hereby affecting the powers of the Architect or the obligations and liabilities of the

Contract the whole of which shall continue in force as fully as if the Contract had not been so determined and as if the works subsequently executed had been executed by or on behalf of the Contractor. The costs of these works are therefore recoverable from the Contractor. And further, the Owner under instructions of the Architect, by his Agents or servants may enter upon and take possession of the works and all plants, tools, scaffolding, sheds, machinery, steam and other power utensils and materials lying upon the premises or the adjoining lands or roads, and use the same as his own property or may employ the same by means of his own servants and workmen in carrying on and completing the works or by employing any other Contractor or other person or persons to complete the Work, and the Contractor shall not in any way interrupt or do any act, matter or thing to prevent or hinder such other Contractor or other person or persons employed for completing and finishing or using the materials and plant for the Work. When the Work shall be completed or as soon thereafter as convenient the Architect shall give a notice in writing to the Contractor to remove his surplus materials and plant, and should the Contractor fail to do so within a period of 14 days after receipt thereof by him, Owner shall sell the same, and shall give credit to the Contractor for the amount realized. The Architect shall thereafter ascertain and certify in writing what (if anything) shall be due or payable to or by the Owner for the value of the said plant and materials so taken possession of by the Owner and the expense or loss which the Owner shall have been put to in procuring the works to be completed, and the amount, if any, owing to the Contractor and the amount which shall be so certified shall thereupon be paid by the Owner to the Contractor or by the Contractor to the Owner, as the case may be, and the certificate of the Architect shall be final and conclusive between the parties.

27. If at any time after the commencement of the work the Owner shall for any reason whatsoever not require the whole thereof, as specified in the tender, to be carried out, but need to abridge the Contract, the Owner shall give notice in writing of the fact to the Contractor who shall have no claim to any payment or compensation which he might have derived from the execution of the work in full, but which he did not derive in consequence of the whole amount of the work not having been carried out. The Contractor shall in this case, however, be entitled to payment for the work already executed by him in accordance with the agreed rates. The Owner shall also take over all building materials as might have been ordered for the work, but orders for which cannot be canceled, if delivered within a reasonable time, and shall pay for them at cost price. The Contractor shall also be allowed to remove his tools and plants from the site.
28. Termination of Contract by Contractor
 - a. If payment of the amount payable by the Owner under Certificate of the Architect /PMC for beyond two months from date of issue of certificate due to reason not attributable to the contractor.
 - b. The Owner commits any 'Act of Insolvency', or
 - c. If the Owner (being an individual, or firm) shall be adjudged an Insolvent, or (being an Incorporated Company or Society) shall have an order made against him or pass an effective resolution for winding up, either compulsorily or subject to the supervision of the Court or voluntarily, or if the Official Assignee or the Owner shall repudiate the contract, or if the Official Assignee or the Liquidator in any such winding up shall be unable within fifteen days after notice to him requiring him so to do, to show to the reasonable satisfaction of the Contractor

- that he is able to carry out and fulfill the Contract and to make all payments due, and to become due there under and, if required by the Contractor, to give security of the same, or
- d. If the works be stopped for three months or more under a continuous spell under the order of the Architect /PMC or the Owner or by any injunction or other order of any Court of Law,
29. Then and in any of the above said (Clause28) cases the Contractor shall be at liberty to determine the Contract by notice in writing to the Owner, through the Architect, and he shall be entitled to recover from the Owner payment for all works executed and cost of the material supplied and lying at site for the purpose of the Contract as on the said day of the termination. No other claim for idle labour , loss of overheads , profits shall be entertained nor shall any other claim on account of the delay in completion of the work /availability of site/ unwarranted conditions whatsoever shall be tenable, even if it is caused by circumstances beyond the Contractor's control.

30. Procedure for Settlement of Disputes

30.1 Engineer's Decision

If a dispute of any kind whatsoever arises between IIIT-Delhi and the contractor in connection with, or arising out of , the contract or the execution of the works, whether during the execution of the works or after their completion and whether before or after any repudiation or other termination of the contract, including any dispute as to any opinion, instruction, determination, certificate or valuation of the engineer, the matter in dispute shall, in the first place, be referred in writing to the engineer, with a copy to all parties. Such reference shall be made within one (1) month of arising of any such dispute and state that it is made pursuant to this clause. No later than one (1) month after the day on which he received such reference the engineer shall give notice of his decision to IIIT-Delhi and the contractor. Such decision shall state that it is made pursuant to the reference under this clause.

Unless the contract has already been repudiated or terminated, the contractor shall in every case, continue to proceed with the works with all due diligence and the contractor and IIIT-Delhi shall give effect forthwith to any / every such decision of the engineer unless and until the same shall be revised, as hereinafter provided, in an amicable settlement or an arbitral award. If either IIIT-Delhi or the contractor be dissatisfied with any decision of the engineer, or if the engineer fails to give notice of his decision on or before one (1) month after the day on which he received the reference, then either IIIT-Delhi or the contractor may within a further period of one (1) month from the day on which it / they receive(s) the notice of such decision, or on the day on which the said period of notice of / for decision expired, as the case may be, give notice to the other party, with copy for information to the engineer, of its / their intention to commence arbitration. Such notice shall establish the entitlement of the party giving the same to commence arbitration, as hereinafter provided, as to such dispute and no arbitration in respect thereof may be commenced unless such notice is given. If the engineer has given notice of his decision as to a matter in dispute to IIIT-Delhi and the contractor and no notification of intention to commence arbitration as to such dispute has been given by either IIIT-Delhi or the contractor as herein

provided, the said decision shall become final and binding upon IIIT-Delhi and the contractor.

30.2. Amicable Settlement

Where notice of intention to commence arbitration as to a dispute has been given in accordance with sub-clause 22.1, arbitration of such dispute shall not be commenced unless an attempt has first been made by the parties to settle such dispute amicably. Provided that, unless the parties otherwise agree, arbitration may be commenced on or after one (1) month from the day on which notice of intention to commence arbitration of such dispute was given, whether or not any attempt at amicable settlement thereof has been made or result achieved.

30.3. Arbitration

Any dispute in respect of which:

- a) the decision, if any, of the engineer has not become final and binding pursuant to the first sub-clause above,
- b) amicable settlement has not been reached within the period stated in the second sub-clause above,

shall be finally settled, unless otherwise specified in the contract, by arbitration to be held in New Delhi in English, under the provisions of the Arbitration and Conciliation Act 1996, including any statutory reenactment(s) / amendment(s) thereof and Rules made thereunder, by the arbitrator. The Director of the Institute shall appoint one person as the sole arbitrator. Either party shall be limited in the proceeding before such arbitrator to evidence or arguments put before the engineer for the purposes of obtaining the said decision pursuant to the first sub-clause herein. No such decision shall disqualify the engineer from being called as a witness and giving evidence before the arbitrator on any matter whatsoever relevant to the dispute. Arbitration proceedings shall not be commenced prior to the completion of the works, unless any major pre-requisite criticality is discerned by the arbitrator, and the obligations of IIIT-Delhi, the engineer and the contractor shall not be altered by reason of the arbitration. The works shall not be stopped on account of the said process of arbitration and the contractor shall not be relieved of his responsibilities for the completion of the work under any circumstances whatsoever.

31.2. Contractor to provide everything necessary

The Contractor shall provide everything necessary for the proper execution of the Work according to the intent and meaning of the Drawings, Schedule of Quantities and Specifications taken together whether the same may or may not be particularly shown or described therein provided that the same can reasonably be inferred there from, and if the Contractor finds any discrepancy in the Drawings or between the Drawings, Schedule of Quantities and Specification he shall immediately and in writing refer the same to the Architect who shall decide which is to be followed.

31.3. Materials and Workmanship to conform to Descriptions

All materials and workmanship shall so far as procurable be of the respective kinds described in the Schedule of Quantities and/or Specification and in accordance with the Architect's Instructions, and the Contractor shall upon the

request of the Architect furnish him with all invoices, accounts, receipts and other vouchers to prove that the materials comply therewith. The Contractor shall at his own cost arrange for and/or carry out any test of any materials which the Architect may require.

31.4. Assignment and Sub-letting

The whole of the works included in the Contract shall be executed by the Contractor and the Contractor shall not directly or indirectly transfer, assign or underlet the Contract or any part share thereof or interest therein without the written consent of the Architect, and no undertaking shall relieve the Contractor from the full and entire responsibility of the Contract or from active superintendence of the Work during its progress.

31.5. Removal of improper work

The Architect shall, during the progress of the Work, have the power to order the removal, from the Site or works within such reasonable time or times as may be specified in the order, of any materials which in the opinion of the Architect are not in accordance with the Specification or the Instructions of the Architect, the substitution of proper materials, and the removal and proper re-execution of any works executed with materials or workmanship not in accordance with the Drawings, Specifications or Instructions and the Contractor shall forthwith carry out such order at his own cost. In case of default on the part of the Contractor to carry out such order, the Owner shall have the power to employ and pay other persons to carry out the same, and all expenses consumed thereon or incidental thereto as certified by the Architect shall be borne by the Contractor, or may be deducted by the Owner from any moneys due or that may become due to the Contractor.

ADDITIONAL CONDITIONS

1. General conditions of contract for Central PWD Works 7/8 (Tender of Form) shall be part of the agreement.
2. The work shall be carried out strictly as per CPWD specifications 2007, Part I & II with up to date correction slips. Wherever no specification is available in the above said document, drawings and specifications supplied with bill of quantities shall be applicable
3. The Contractor shall have to clear the site for the work of all overlying rubbish /garbage/dumped refuse material prior to commencement of the work in case required at no extra cost. The contractor shall take approval from the Engineer /Officer in Charge in writing for collection and stacking of materials.
4. The contractor must follow CPWD Safety Code as provided in general conditions of contract for CPWD Works.
5. Any damage done by the contractor or his workmen to any existing work during the course of execution of the work shall be made good by him at his own cost.
6. Contractor shall clear the site thoroughly of all rubbish etc. left out of his materials immediately on completion of the work and properly keep the site clean around the building to the satisfaction of the Engineer- in-Charge.
7. The preference of the codes will be IS codes.
8. The rates are inclusive of all staging, material and labour as required for the works. The items in the bill of quantities include all the materials, labour, and installation, complete as a finish items unless otherwise stated.
9. Unless specifically mentioned otherwise, quoted Rates shall be deemed to include work to be carried out at all curvatures, heights, depths, inclinations and locations, and in wet/foul locations, as and when they are encountered. The rates quoted for the various works as specified in the Priced Schedule of Quantities are work in all types of soils/rock and prevailing Site conditions including earth work, excavation, shoring, execution of various other items of work, i.e., laying of pipes, joining, concreting, masonry, plastering, etc. in and under water and dewatering as required. Nothing extra is payable on this account.
10. All security precautions shall be taken during dismantling work. The site shall be fenced /barricaded with suitable material during construction period .No payment shall be made for fencing/barricading work. Fencing/barricading shall be done immediately after possession of site and shall be removed after completion of construction period
11. No space on site/otherwise for labour huts shall be provided by IIITD, cost of same shall be borne by contractor.
12. The general condition of contract for Central P.W.D. Works has reference of various laws /acts /rules. The settlement of any disputes and arbitration, only Indian arbitration and conciliation act 1996 shall be applicable.
13. In case any specific brand of material has been specified either the same brand or of approved make of same specifications shall be used. The contractor shall take approval in advance for all such materials.
14. Costs for all materials and labour for the preparation of samples, market research, etc. shall be borne by the Contractor within his quoted Rates and nothing extra shall be payable for this. The works shall not be proceeded with without approval of the sample. In case sample is rejected and works cannot be proceeded with the IIITD shall be at liberty to terminate the contract and the Contractor shall have no claim for the works under such circumstances whatsoever.
15. The contractor should take utmost care to avoid any damage to the existing structures, walls , finishing , flooring, electrical works/cables, telephone cables, false ceiling,

- sprinkler system, fire alarm etc. in place. In case of any damage, it would be the responsibility of the contractor to restore the same immediately.
16. The contractor may have to carry out the works in odd hours of day and night as per academic schedule of the Institute and no extra charges shall be payable.
 17. The works may have to be suspended from time to time as per academic requirements. No extras/escalation will be payable except for suitable extension of time of upto time as per GCC of the CPWD.
 18. All protocols/guidelines for preventing spread of Covid 19/ Cov2 SARS virus strains need to be followed by the Contractor/s as per Govt . / IIITD authorities Guidelines issued from time to time.
 19. Necessary guidelines for Environmental Protection as per local /State Govt/ Central Govt Authorities as applicable shall be followed by the Contractor/s.

CORRIGENDUM TO FORM 7/ 8 / 9 (CPWD) MUST BE READ ALONG WITH THE PAMPHLET

S.No	FOR	READ
1	Government of India/Owner	Indraprastha Institute of Information Technology Delhi
2	C.P.W.D. or Government or Department	Indraprastha Institute of Information Technology Delhi
3	CPWD -7/8/9	CPWD 7/8/9
4	President / President of India	Chairman ,BOG,IIITD
5	Chief-Engineer	Director ,IIITD
6	Superintending Engineer	CE, IIITD
9	Administration Head	Registrar ,IIITD
11	CPWD Code, Paragraph '90	Shall be applicable to IIITD works
12	DSR' Latest	Shall be applicable to IIITD works
13	CPWD specifications Latest part - I& II	Shall be applicable to IIITD works
14	DSR (Internal) Latest for Electrical works	Shall be applicable to IIITD works
15	CPWD specifications (Internal) Latest for Electrical works	Shall be applicable to IIITD works
16	DSR External Latest for Electrical works and specifications	Shall be applicable to IIITD works
17	Provision of Section 12 Sub-Section (i) of the works man compensation	Shall be applicable to IIITD works
18	CPWD safety Code framed from time to time	Shall be applicable to IIITD works
19	CPWD maternity benefits to labour	Shall be applicable to IIITD works
20	Model Rules of the protection of health and sanitary appointment for workers employed by CPWD	Shall be applicable to IIITD works
21	CPWD contractor labour Regulations	Shall be applicable to IIITD works

SPECIFICATIONS:

1. GENERAL:

- 1.1. Without forgoing the requirements of the conditions of Tender and the Conditions of Contract the works in general shall conform to the "Specifications Latest as published by CPWD, New Delhi and the "Specifications for works" stated in this tender. In case items not covered by the general specifications referred above, reference shall be made to the appropriate I.S. Codes. If there is any difference in the particular specifications of individual item of work and the description of item as given in the Schedule of quantity, the latter shall prevail. In case of any work for which there is no specification in I.S. specifications in the specifications forming part of tender documents or in case there is any variation, such work shall be carried out in all respects in accordance with the instructions to be issued by the Engineer-in-charge. The term Officer in Charge appearing in the specifications shall mean supervisor and be in Charge of the work or his authorized representative as the context may demand. All corrections to "Specifications Latest" or latest revisions of I.S. Code/ Specification shall be deemed to apply to this contract.
 - 1.1.1. Materials bearing ISI certification mark certification shall be given highest preference for use in the works. Where the Contractor is required to do, perform, execute (etc.) any work or service or the like, it shall be deemed to be at his own cost. Absence of terms providing, Supplying, installing, fixing, etc. shall not even remotely entitle the Contractor to any additional payment there for
 - 1.1.2. The rates accepted in the Schedule of Quantities apply to all floors, heights, depths, leads, lifts, spans, sizes, shapes, locations, etc. unless a distinction has been included in the very Schedule.
 - 1.1.3. The Specifications and the Schedules may have been divided into various sub-heads for convenience only. This does not limit applicability of one to the other nor does it absolve the Contractor of his responsibility to complete any trade / item of work as reasonably inferred from one or more of such sub-heads.
 - 1.1.4. The Schedule of Quantities is not necessarily based on "Schedule of Rates - Delhi latest or any of its later/ earlier versions. Hence the Schedule of Quantities shall be read and construed according to explanations given herein and intentions gathered there from. A mere parallel drawn from the said Schedule of Rates shall therefore not form a basis for a variation and, or additional payment.
 - 1.1.5. All work under this contract is deemed to be performed above subs soil water level. However, removal of water collected from rains and the like shall be treated as part of contractual risk/obligation.
 - 1.1.6. Screws, bolts, nuts, washers, hold fasts, lugs, anchors, clamps, plugs, suspenders, brackets, straps and fasteners of the like are deemed to be included in the rates of various items unless the Schedule of Quantities expressed a different intention.
 - 1.1.7. Resetting any displacements, making good holes/chases and such other incidental jobs are included in rates of respective items for which these are required.

2. DRAWINGS, SPECIFICATIONS, INTERPRETATIONS ETC.:

In general, drawings shall indicate the dimensions, positions and type of construction, the specifications shall stipulate the qualities and the methods and performance criteria, and the schedule of quantities shall indicate the provisional quantities and the rates for each item of work. However, the above documents being complementary, what is called for by any one shall be as binding as if called for by all. In case of contradictory requirements between specifications and schedule of quantities, the requirements given in the schedule of quantities shall prevail.

Special conditions being mainly an amplification of General Conditions, they shall be read in conjunction with each other.

Work indicated on the drawings and not mentioned in the schedule of quantities or specifications or vice versa, shall be deemed as though fully set forth in each. Work not specifically detailed, called for, marked or specified, shall be the same as similar parts that are detailed, marked or specified.

Special Note

Though every care is taken while preparing this document to cover all necessary matters, specifications, general conditions, special conditions, provisions for smooth and complete execution of work, however in case of any omission in the tender/ contract document, latest correction slips of General Conditions of Contract for CPWD Works will be the reference manual but not in supersession to aforesaid conditions.

Contractor should depute a qualified supervisor dedicated for this work, who will monitor and coordinate work from contractor's side and interact with the IIITD Engineers, responsible for supervision of work, on regular basis.

Contractor will take due permission for entry of all his workers in IIITD. No unauthorized person will be allowed to work inside. During execution of work, Engineer may make minor changes in the scope of work as per site conditions or other reasons. Contractor will have no extra claim in his rates for the same.

All standard protocols such as wearing masks, using sanitizer, maintaining safe distancing norms must be followed by the Contractor and his workers to prevent spread of coronavirus failing which expulsion/ penalty shall be levied on the agency.

The workers shall be scanned for temperature before entry as per norms and actions per policy taken.

All are supposed to use identified utilities of the Institute only.

AGREEMENT

AN AGREEMENT is made this -----BETWEEN the Indraprastha Institute of Information Technology. A State University established by Govt Of NCT of Delhi ,and with its registered office at IIITD Campus , Okhla Phase III , New Delhi 110020, which expression shall include its successor, unless repugnant to or Excluded by the contract here of and assignees of and represented by its Registrar, IIITD the first party (hereinafter called the Authority) and by its sole proprietor/partners/Director.of M/s -----and having registered office at ----- (which expression shall be including his / its successor's heirs, executors, representative and or assignees of the second party (hereinafter called the contractor}).

WHEREAS the Authority has, under tender Notification No. -----

-----.
WHEREAS the contractor has submitted tender for carrying out the work as above as per the tender document page ---- to ----- and has represented that in conformity with his / its obligation contained in the tender as modified by the correction slips and corrigendum contained he / it shall carryout the same truly, faithfully and honestly.

THE SAME has been accepted by both the parties on the terms and conditions, corrections, corrigendum contained in the tender as modified as well as the letter of acceptance Issued party No.1 annexed here to as.

The same shall be binding on both the parties.

IN WITNESS WHEREOF, the parties have signed the deed of agreement on the date, month and year referred to above.

Date: -----

At New Delhi.

Signed by

Party No.1

Party No.2

WITNESS

1. ----- Party No.1

2. ----- Party No.2

List of Approved Make :

1. Cement - ACC, ULTRATECH, SHREE , BIRLA, AMBUJA , J.K..
2. Reinforcement - SAIL, TISCO, RINL, JSPL. JSW
3. Structural Steel and Roof sheets - SAIL, TISCO, RINL, JSPL, JSW
4. Galvanised sheet- SAIL, TATA, GSW
5. Anchor fastner - HILTI, FISCHER, BOSCH, CANON
6. Nuts, Bolts and screws - KUNDAN, PRIYA, ATUL, PUJA
7. Epoxy paint - M/s Asian Paints Ltd , M/s Berger Paints India Ltd, M/s ICI India Ltd.

Drawing

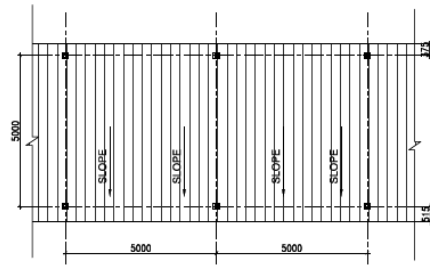

PARKING ROOF LEVEL PLAN

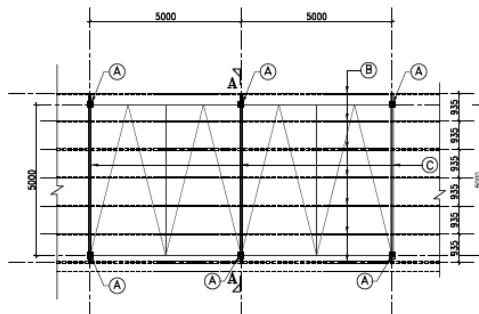

PARKING BOTTOM LEVEL PLAN

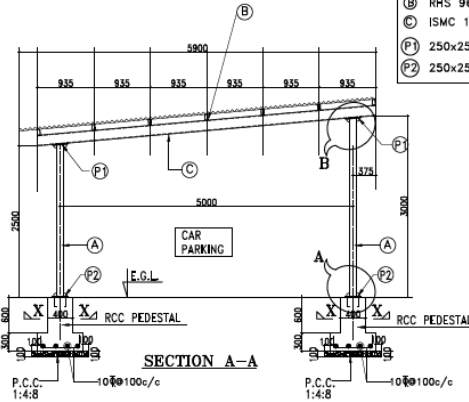

SECTION A-A

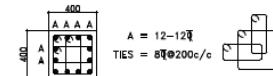

SECTION X-X (RCC PEDESTAL DETAIL)

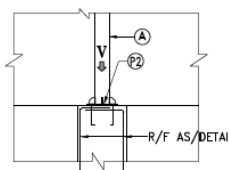

DETAIL-A

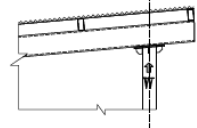

DETAIL-B

- (A) SHS 115x115x4.8
- (B) RHS 96x48x4.0
- (C) ISMC 175
- (P1) 250x250x8mm THK. PLATE
- (P2) 250x250x10mm THK. PLATE

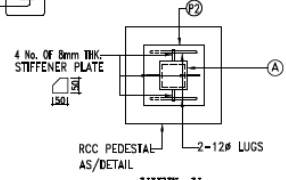

VIEW-V

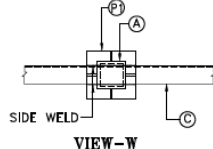

VIEW-W



Bill of Quantities

S.no	Items	Unit	Qty	Rate	Amount
1	Providing and fixing precoated galvanised iron profile sheets (size, shape and pitch of corrugation as approved by Engineer-in-charge) 0.50 mm (+ 0.05 %) total coated thickness with zinc coating 120 grams per sqm as per IS: 277, in 240 mpa steel grade, 5-7 microns epoxy primer on both side of the sheet and polyester top coat 15-18 microns. Sheet should have protective guard film of 25 microns minimum to avoid scratches during transportation and should be supplied in single length upto 12 metre or as desired by Engineer-in-charge. The sheet shall be fixed using self drilling /self tapping screws of size (5.5x 55 mm) with EPDM seal, complete upto any pitch in horizontal/ vertical or curved surfaces, excluding the cost of purlins, rafters and trusses and including cutting to size and shape wherever required. Plan area of the precoated galvanised iron profile sheets shall be measured, no extra shall be paid for overlaps.	Sqm	750		
2	Structural steel work riveted, bolted or welded in built up sections, trusses and framed work, including cutting, hoisting, fixing in position and applying a priming coat of approved steel primer all complete.	Kg	12850		
3	Providing and laying in position machine batched and machine mixed design mix M-25 grade cement concrete for reinforced cement concrete work, using cement content as per approved design mix, including pumping of concrete to site of laying but excluding the cost of centering, shuttering, finishing and reinforcement, including admixtures in recommended proportions as per IS: 9103 to accelerate, retard setting of concrete, improve workability without impairing strength and durability as per direction of Engineer-in-charge. (Note :- Cement content considered in this item is @ 330 kg/cum. Excess/ less cement used as per design mix is payable/recoverable separately).	Cum	17		
4	Centering and shuttering including strutting, propping etc. and removal of form for : Foundations, footings, bases of columns, etc. for mass concrete	Sqm	70		
5	Steel reinforcement for R.C.C. work including straightening, cutting, bending, placing in position and binding all complete upto plinth level.	Kg	1870		
6	Providing and laying in position cement concrete of specified grade excluding the cost of centering and shuttering - All work up to plinth level : 1:4:8 (1 Cement : 4 coarse sand (zone-III) : 8 graded stone aggregate 40 mm nominal size)	Cum	3		
7	Earth work in excavation by mechanical means (Hydraulic excavator)/ manual means over areas (exceeding 30 cm in depth, 1.5 m in width as well as 10 sqm on plan) including getting out and disposal of excavated earth lead upto 50 m and lift upto 1.5 m, as directed by Engineer-in charge.	Cum	26		
8	Disposal of moorum/building rubbish/ malba/ similar unserviceable, dismantled or waste material by mechanical transport including loading, transporting, unloading to approved municipal dumping ground for lead upto 10 km for all lifts, complete as per directions of Engineer-in-charge.	Cum	9		

9	Finishing with Epoxy paint (two or more coats) at all locations prepared and applied as per manufacturer's specifications including appropriate priming coat, preparation of surface, etc. complete.	Sqm	350		
10	Filling available excavated earth (excluding rock) in trenches, plinth, sides of foundations etc. in layers not exceeding 20cm in depth, consolidating each deposited layer by ramming and watering, lead up to 50 m and lift upto 1.5 m.	Cum	10		
11	Dismantling, removal and relaying existing precast Cement Concrete grass paver blocks over a layer of jamuna sand as required.	Sqm	110		
12	Wiring for circuit/ submain wiring alongwith earth wire with the following sizes of FRLS PVC insulated copper conductor, single core cable in surface/ recessed medium class PVC conduit as required.				
(i)	2 X 1.5 sq. mm + 1 X 1.5 sq. mm earth wire	M.	150		
13	Installation, testing and commissioning of pre-wired, fluorescent fitting / compact fluorescent / LED fitting of all types, complete with all accessories etc. in recess/directly on ceiling / wall, including connection with 1.5 sq.mm FR PVC insulated, copper conductor, single core cable and earthing etc. as required.	Nos	25		
	TOTAL AMOUNT				
	GST @				
	TOTAL AMOUNT WITH GST				

Note: All rate to be inclusive cost of Transportation, Labour, Materials etc. as required for satisfactory completion of work.